

Data Sheet



Article number: 2307083753

Description: E+G Direct drive position indikator
DD52R-FR-0005.0-D-C2 (Orange)

Measures

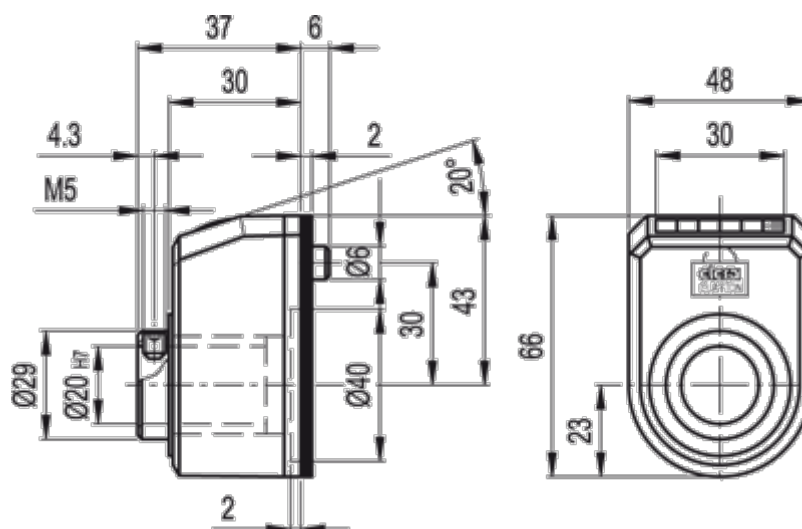

Max rpm = 500